

415403		BR 055	DB	=	HO
Pos. Nr. Pos.no.	Beschreibung Description	Art.-Nr. Art.no.	Preisgruppe Price bracket		
1	LOKGEHÄUSE KPL. Body assembly complete	10415403	033		
2	PROFI-STECKKUPPLUNG Profi clip-in coupling	6515	---		
3	LICHTLEITER-LOK /SATZ Light conductor for loco set	13481305	009		
4	UMLAUFBLECH Running board	15415403	018		
5	PFEIFE Whistle	00194607	004		
	ANTENNENATTRAPPE (o.Abb.) Antenna dummy (w/o Illustr.)	00194701	004		
7	REICHSBAHNLAMPE REICHSBAHN lamp	00194811	008		
8	KUPPLUNGSHAKEN Coupling hook	00194824	002		
9	BREMSSCHLAUCH Brake hose	00194831	002		
	GRIFSTANGEN-SATZ (o.Abb.) Set of handles (w/o Illustr.)	19490600	011		
	LUFTKESSEL karminrot (o.Abb.) Air tank red (w/o Illustr.)	19490900	003		
	BREMSSZYLINDER (o.Abb.) Brake cylinder (w/o Illustr.)	19491000	003		
13	TENDERGEHÄUSE KPL. Tender body complete	20415403	020		
14	TREPPEN F.TENDER /S. Treadles for tender	22481304	011		
	LICHTLEITER-TENDER /SATZ (o.Abb.) Light conductor for tender set (w/o Illustr.)	23481305	009		
16	TENDERBESCHWERUNG Tender ballast	26415401	016		
17	LOKFAHRGESTELL KPL. Loco chassis complete	30415403	043		
18	ABDECKPLATTE MIT BREMSATRAPPE Cover plate with brake dummy	31481304	016		
19	STEUERUNG KPL. Reversing gear complete	32481304	032		
20	ZYLINDERKASTEN Cylinder box	33415403	014		
21	LOK-TENDERKUPPLUNG-SATZ Coupling between loco and tender -set	00344139	009		
22	KUKU-DEICHSEL Short coupling reception	38405100	012		
23	TENDERFAHRGESTELL KPL. Tender chassis complete	40415403	036		
24	TENDERRAHMEN KPL. Tender framework complete	41415403	022		
25	BREMSEGESTÄNGETRÄGER Brake rigging support	43481304	009		
26	MOTOR MIT FAHRGESTELL Motor with chassis	50415401	033		
27	ANKER KPL.M.SCHWUNGMASSE Rotor complete with integr. flywheel	00504607	025		
28	LAGERSCHILD ISO.M.SCHNITTST. Motor PCB, insulated, with interface	00504737	020		
29	KOHLENROHRKAPPE Brush pipe cap	00504801	002		
30	T.-U.VORLAUFRAD O.Z.O.N.ROT Tender&bogie wheel w/o gear,w/o trac.tyre red	00514188	006		
31	T.-U.VORLAUFR.O.Z.O.N.ISO.ROT Tender&bogie wheel w/o gear,w/o trac.tyre red	00514189	007		
32	LOKRAD N.H.KL.BOHRG.ROT LACK. Loco wheel small counterweight red painted	00514263	007		
33	LOKRAD N.H.GR.BOHRG.ROT LACK.U Loco wheel small counterweight red painted	00514265	008		
34	LOKRAD H.H.KL.BOHRUNG ROT LACK Loco wheel big counterweight, red painted	00514315	008		
35	LOKRAD H.H.KL.BOHRUNG ROT LACK Loco wheel big counterweight, red painted	00514316	008		
36	VORLAUF- U. TENDERRAD ROT LACK Tender&bogie wheel red painted	00514378	009		
37	TENDERRAD M.N. ROT LACK. Tender wheel w.traction tyre red painted	00514379	009		

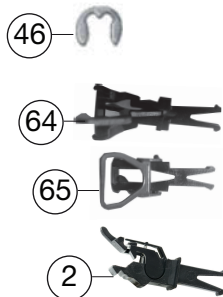

415403		BR 055	DB	=	HO
Pos. Nr. Pos.no.	Beschreibung Description	Art.-Nr. Art.no.	Preisgruppe Price bracket		
38	VORL.- U.TENDERRAD O.N. ROT LA Tender&bogie wheel w/o trac.tyre red painted	00514380	007		
39	ACHSE Axle	00524011	001		
40	HAFTREIFEN HO Traction tyre	00544007	001		
41	ZAHNRAD Z:22 SCHWARZ Gear wheel Z=22 black	00564125	002		
42	ZAHNRAD rot Gear wheel red	00564146	007		
43	UNTERSETZUNGSRAD Reduction gear wheel	00564151	005		
44	UNTERSETZUNGSRAD Reduction gear wheel	00564152	005		
45	RITZEL Z:10 Gear wheel Z=10	00564602	004		
46	SICHERUNGSRING GROSS Securing ring,big	00564702	001		
	UNTERLEGSCH. ROT 2,2X5X0,3 (o.Abb.) Washer (w/o Illustr.)	00564747	001		
	UNTERLEGSCH. ROT 2,2X5X0,3 (o.Abb.) Washer red (w/o Illustr.)	00564751	001		
49	STROMABNEHMEREINSATZ Power pick-up assembly	60481304	018		
50	KONTAKTFEDER (TENDER) Contact spring (Tender)	00614946	001		
	ERSATZ-SCHLEIFKOHLEN (o.Abb.) Carbon brushes set (w/o Illustr.)	6519	---		
52	KONTAKTPILZGARNITUR Contacter pin assembly	64441800	008		
53	LEITERPLATTE PCB	65717300	020		
	LEITERPLATTE (TENDERBELEUCH. (o.Abb.) PCB (Tender Illumination) (w/o Illustr.)	65717400	014		
55	SCHNITTST.BLINDSTECKER 6-POL. Jumper 6-pin	66401800	013		
56	SCHRAUBE Screw	00700307	001		
57	SCHRAUBE Screw	00700313	001		
58	SCHRAUBE B 2,2 x 13 Screw B 2,2 x 13	00713513	001		
59	SCHRAUBE Screw	00713516	001		
60	GEST.BOLZEN KURZ Short linkage pin	00730552	002		
61	STECKPUFFER GEWÖLM.WEIB.RING Plug-in buffer, curved	00754040	006		
62	STECKPUFFER FLACH.M.WEIB.RING Plug-in buffer,flat	00754041	006		
63	PUFFERBOHLE KOMPLETT Frontside framework, complete	75415403	019		
64	STECKKUPPLUNG Clip-in coupling	6510	---		
65	STECK-TAUSCHKUPPLUNG Clip-in coupling	6511	---		

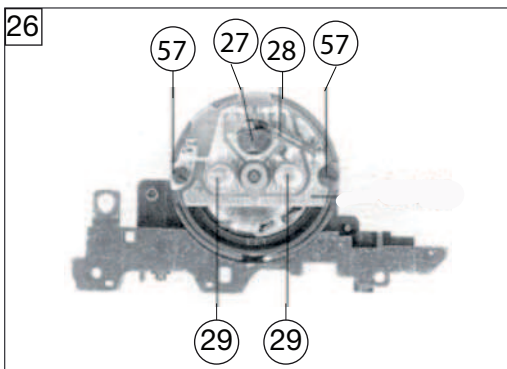
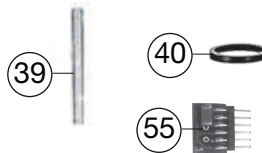
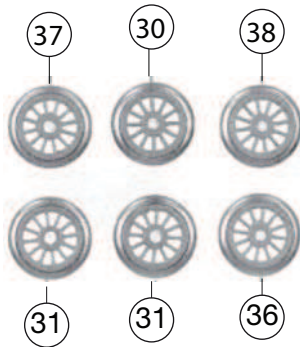
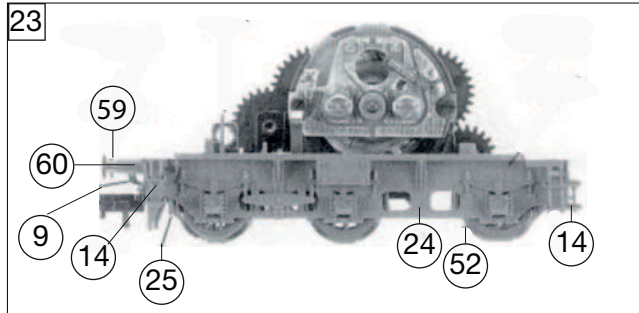
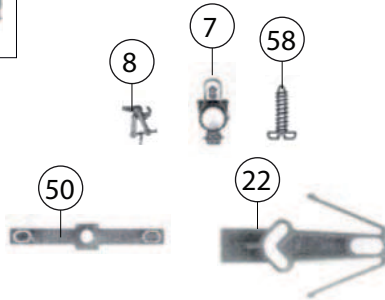
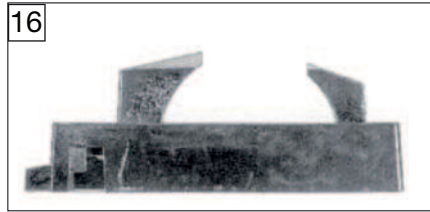
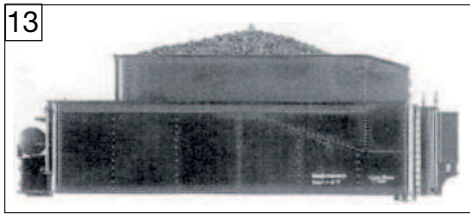